

# Isolating Base

弹簧型中央空调防振架台

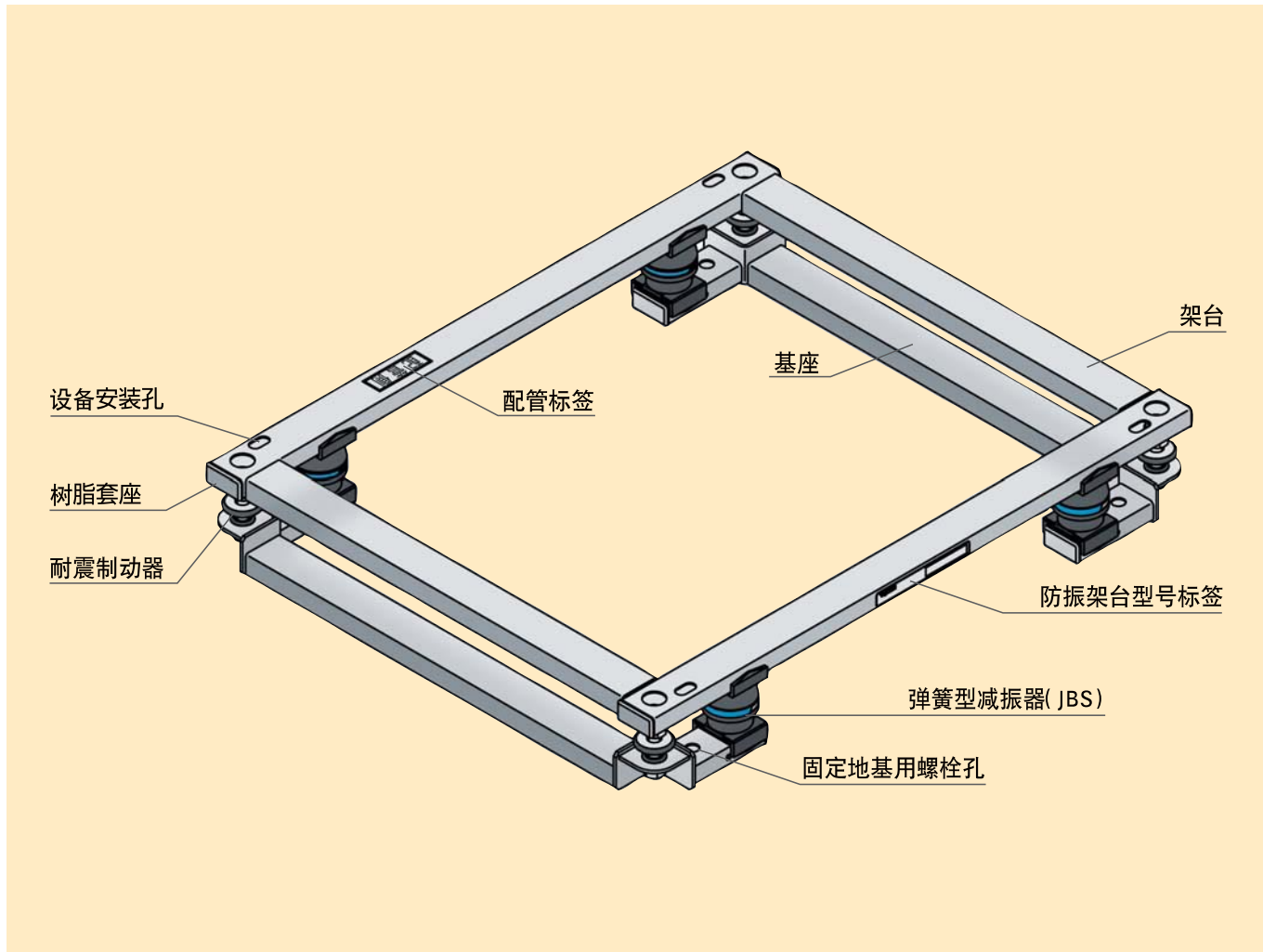

## 特征

- 单体结构

分量轻, 使安装操作更便捷。

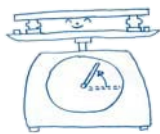

- 耐腐蚀标准规格

因采用热镀锌方式, 所以拥有高效的防锈效果。



- 排水效果好

防积水结构

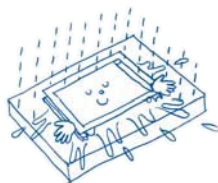

- 抗震性能水平抗震

可使设备在 2.0G 强风时产生的晃动控制在最小范围内。



- 采用金属线圈弹簧

橡胶顶盖遮风挡雨, 能有效地延长弹簧的使用寿命。



- 可适用于地脚施工

备用地脚金属配件( 可选项 )

## 施工例



## 配件

设备安装螺栓  
地基螺栓用角座金属件

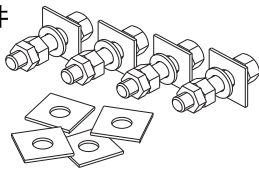

## 可选项

底板(材质:SUS304)  
PLL-0310/0315  
各 10 片 / 袋

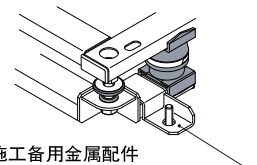
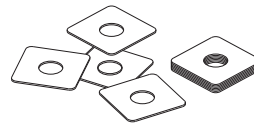

调整设备基座高度时使用

地脚施工备用金属配件  
(4 个 / 组)

## 振动实验测试数据

室外机运转时的防振效果检测

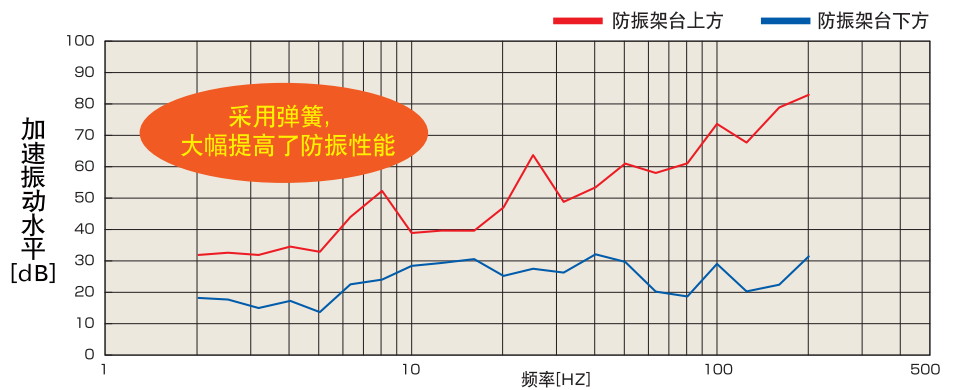

预防因加压机振动导致的阀簧颤动的性能确认试验

